

### DINC 3-AXIS INCLINOMETER, DUAL MODULE



- Two inclinometers which report master and slave position via one J1939 communication line
- Sense true position regardless of orientation (X, Y, and Z)
  - Easily find change in position between base and boom
- Totally sealed IP69K (connector dependent)
- Wide operating temperature range, -40°C to +80°C
- J1939 CAN Bus or varying voltage output
- 'Electronic Bubble' LEDs display level status
- Configuration available through J1939 for sensitivity and angular range settings

<b>ELECTRICAL</b>	<b>Outputs</b>	<b>B-1939</b> : J1939, Addressable, 3-axis reporting <b>B-ANLG</b> : Contact Joral to build custom analog signal
	<b>Input Power</b>	6 to 30 VDC (90 mA)
	<b>Electrical Protection</b>	Over-voltage, reverse-voltage, output short-circuit protected
	<b>LED Indicators</b>	Power, J1939 communication status, level status, and X/Y level condition
	<b>Connections</b>	M12, M12 Pigtail, Flying Lead Cable, Shielded Flying Lead, or Deutsch - 4 or 6 pin
	<b>Resolution</b>	0.1°
	<b>Absolute Accuracy (at 25°C)</b>	± 0.3°

<b>MECHANICAL</b>	<b>Housing Style</b>	Rectangular tabbed
	<b>Housing Material</b>	Plastic or Anodized Aluminum (high temperature applications)
	<b>Housing Height</b>	Plastic - 1.0"; Aluminum - Contact Joral
	<b>Housing Width</b>	Plastic - 1.5"; Aluminum - Contact Joral
	<b>Housing Length w/ Tabs</b>	Plastic - 3.0"; Aluminum - Contact Joral
	<b>Mounting</b>	Tabs (0.187 diameter holes)
	<b>Weight</b>	Master - 3.0 oz; Slave - 2.0 oz

<b>ENVIRONMENTAL</b>	<b>Operating Temperature</b>	-40° to +80° C
	<b>Temperature Drift</b>	±0.3 degrees across specified operating temperature limits
	<b>Storage Temperature</b>	-40° to +90° C
	<b>Humidity</b>	100%
	<b>Shock</b>	400g/6ms ( <i>MIL STD 202</i> )
	<b>Vibration</b>	5 to 3000 Hz, 20g ( <i>MIL STD 202</i> )
	<b>Protection Class</b>	IP69K ( <i>connection dependent</i> )

		Code 1: Housing Style	Code 2: MagElec	Code 3: Connection	Code 4: Modifiers		
<b>ORDER TABLE</b>	<b>DINC</b> Black Plastic housing standard, not rated for high temp applications	<b>B-1939</b>	J1939, Addressable, 3-axis position reporting	<b>M12</b>	M12 male	<b>51</b>   Red Aluminum	
		<b>B-ANLG</b>	Contact Joral to build custom analog signal	<b>M12P</b>	M12 male on 18' pigtail	<b>53</b>   Black Aluminum	
	<b>DINC Modifier Red Aluminum:</b> DINC-[Code 2]-[Code 3]-51 Special code 51 (53) for anodized red (black) aluminum high temp housing			<b>CXX</b>	Flying lead cable (enter XX as inches)		
				<b>SCXX</b>	Shielded cable (enter XX as inches)		
				<b>DE4</b>	DT04-4 pin male Deutsch		
				<b>DE6</b>	DT04-6 pin male Deutsch		
		*More outputs and connection options available, contact Joral if desired configuration is not listed					

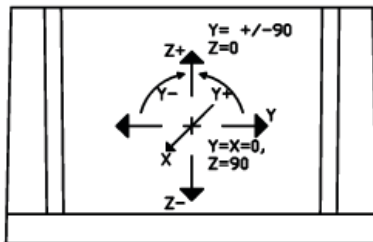
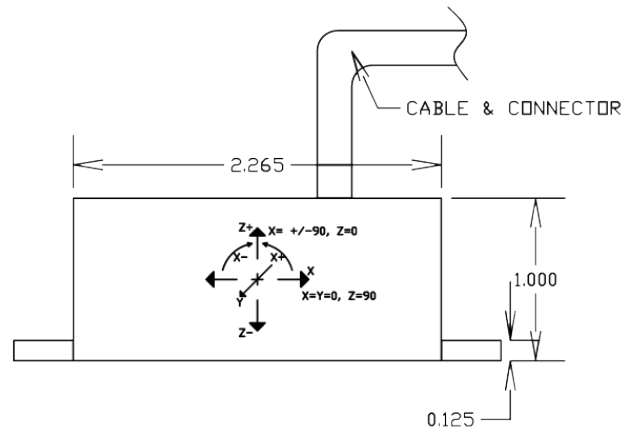
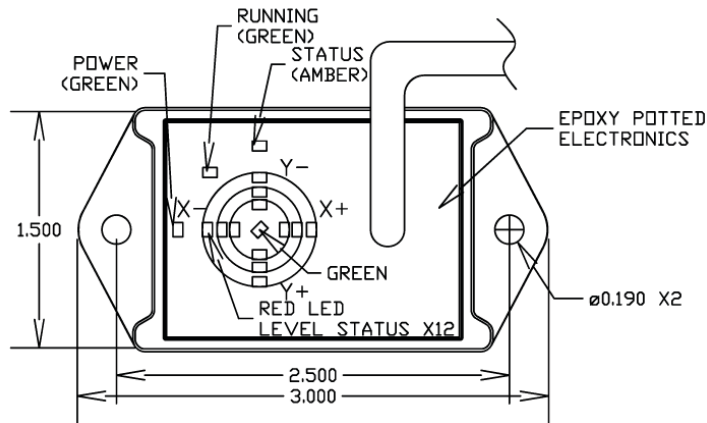

### GENERAL PIN OUTS

**DT04-4P MALE  
FACE VIEW**

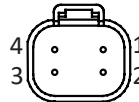

**DT04-4P J1939 OUTPUT**

- 1 = YEL = CAN HIGH
- 2 = GRN = CAN LOW
- 3 = RED = +VDC (VIN)
- 4 = BLK = COMMON/GROUND

**DT04-6P MALE  
FACE VIEW**



**DT04-6P J1939 OUTPUT**

- 1 = YEL = CAN HIGH
- 2 = GRN = CAN LOW
- 3 = RED = +VDC (VIN)
- 4 = BLK = ADDRESS GROUND
- 5 = WHT = ADDRESS PROG. RESISTOR
- 6 = BLK = COMMON/GROUND

**M12-5P MALE  
FACE VIEW**

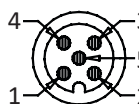

**M12-5P AND 5 CONDUCTOR  
CABLE J1939 OUTPUT**

- 1 = BRN = +VDC (VIN)
- 2 = WHT = CAN HIGH
- 3 = BLUE = COMMON/GROUND
- 4 = BLK = CAN LOW
- 5 = GRY = OPTIONAL ADDRESS PROGRAMMING RESISTOR

*Dimensions informative only  
For most recent dimensions please consult factory*

### MESSAGE PARAMETERS

This message is transmitted to the sensor at the REP rate

PGN: 65290 (FF0A hex)	
Transmission Repetition Rate	n/a
Data Length	n/a
Data Page	0
PDU Format	255 (FF hex)
PDU Specific	10 (0A hex)
Priority	7
Source Address+Adr Offset	249
Communication Bit Rate	250 K bits/sec

Field	Size/Bits	Description
Sensitivity Setting	3 bits / 0 to 2	0 = most sensitive, 7 = most sluggish (default 4)
LED Weight Setting	3 bits / 5 to 7	The desired degrees per LED indicator is entered in this field. The desired degrees per LED indicator has to be between 1 to 7 (default 1)
Calibrate/Home Field (Master)	2 bits / 8 to 9	01 = Calibrate/Home the master sensor at the current angles
Calibrate/Home Field (Slave)	2 bits / 10 to 11	01 = Calibrate/Home the slave sensor at the current angles

Note: Set reserved and unused bits to all 0's or all 1's

Encoder Transmitted Source Address Selection			
Tag #	Ohms	Address	PGN
	No resistor	NA	65290 FF0A hex
1	590	NA	65291 FF0B hex
2	976	NA	65292 FF0C hex
3	1500	NA	65293 FF0D hex
4	2260	NA	65294 FF0E hex
5	3400	NA	65295 FF0F hex
6	5360	NA	65296 FF10 hex
7	9530	NA	65297 FF11 hex

DT04-4P MALE FACE VIEW



DT04-4P J1939 OUTPUT

- 1 = YEL = CAN HIGH
- 2 = GRN = CAN LOW
- 3 = RED = +VDC (VIN)
- 4 = BLK = COMMON/GROUND

M12-5P MALE FACE VIEW

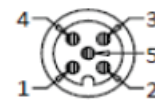

DT04-6P MALE FACE VIEW



DT04-6P J1939 OUTPUT

- 1 = YEL = CAN HIGH
- 2 = GRN = CAN LOW
- 3 = RED = +VDC (VIN)
- 4 = BLK = ADDRESS GROUND
- 5 = WHT = ADDRESS PROG. RESISTOR
- 6 = BLK = COMMON/GROUND

M12-5P AND 5 CONDUCTOR CABLE J1939 OUTPUT

- 1 = BRN = +VDC (VIN)
- 2 = WHT = CAN HIGH
- 3 = BLUE = COMMON/GROUND
- 4 = BLK = CAN LOW
- 5 = GRY = OPTIONAL ADDRESS PROGRAMMING RESISTOR

Arbitration Field																								Control Field																			
0	1	2	3	4	5	6	7	8	9	10	11	12	13	14	15	16	17	18	19	20	21	22	23	24	25	26	27	28	29	30	31	32	33	34	35	36	37	38					
SOF	Priority 3 Bits			R1	DP	PDU Format (PF) 8 bits						SRS	IDE	PF Cont.		PDU Specific 8 bits						Source Address 8 bits						RTR	Control Field 6 bits														
X	0	1	2	0	0	0	1	2	3	4	5	X	X	6	7	0	1	2	3	4	5	6	7	0	1	2	3	4	5	6	7	X	0	1	2	3	5	6					
	1	0	0	0		1	1	1	1	1	1			1	1	1	0	1	1	1	1	0	0	1	1	1	0	1	1	1	0	0											
	7				255 (FF hex)								10 (0A hex)						249 (F9 hex)																								
	65290 + Address Offset																							249 Mandatory																			



### MESSAGE PARAMETERS

This message is transmitted by the sensor at the REP rate

Master PGN: 65467 (FFBB hex)	
Transmission Repetition Rate	50ms
Data Length	8 bytes
Data Page	0
PDU Format	255 (FF hex)
PDU Specific	185 (BB)
Priority	4
Source Address+Adr Offset	219 (DB hex)
Communication Bit Rate	250 K bits/sec

Slave PGN: 65466 (FFBA hex)	
Transmission Repetition Rate	50ms
Data Length	8 bytes
Data Page	0
PDU Format	255 (FF hex)
PDU Specific	185 (BA)
Priority	4
Source Address+Adr Offset	219 (DB hex)
Communication Bit Rate	250 K bits/sec

Field	Size/Bits	Description
X Angle	10 bits / 0 to 9	The X angle is a value between 0-1000 and there is 0.1° per bit
X Positive Flag	2 bits / 10 to 11	01 = X angle is a positive angle
X Negative Flag	2 bits / 12 to 13	01 = X angle is a negative angle
Y Angle	10 bits / 14 to 23	The Y angle is a value between 0-1000 and there is 0.1° per bit
Y Positive Flag	2 bits / 24 to 25	01 = Y angle is a positive angle
Y Negative Flag	2 bits / 26 to 27	01 = Y angle is a negative angle
Z Angle	10 bits / 28 to 37	The Z angle is a value between 0-1000 and there is 0.1° per bit
Z Positive Flag	2 bits / 38 to 39	01 = Z angle is a positive angle
Z Negative Flag	2 bits / 40 to 41	01 = Z angle is a negative angle
Sensitivity Setting	3 bits / 56 to 58	The sensitivity setting field contains the value of the current sensitivity setting. The setting is between 1 to 7 and this represents the degrees per LED indicator.
LED Weight Setting	3 bits / 59 to 61	The LED weight setting field contains the value of the current LED weight setting. The setting is between 1 to 7 and this represents the degrees per LED indicator.

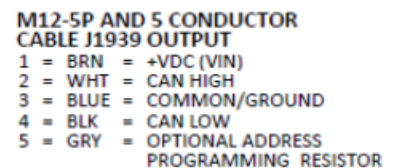
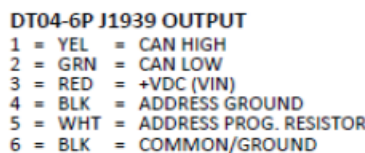
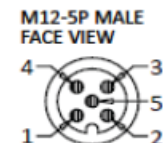
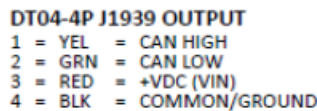
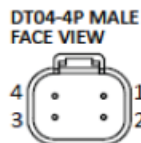

Master Encoder Transmitted Source Address Selection			
Tag #	Ohms	Address	PGN
	No resistor	220	65467 FFBB hex
1	590	221	65467 FFBB hex
2	976	222	65467 FFBB hex
3	1500	223	65467 FFBB hex
4	2260	224	65467 FFBB hex
5	3400	225	65467 FFBB hex
6	5360	226	65467 FFBB hex
7	9530	227	65467 FFBB hex

Slave Encoder Transmitted Source Address Selection			
Tag #	Ohms	Address	PGN
	No resistor	220	65466 FFBA hex
1	590	221	65466 FFBA hex
2	976	222	65466 FFBA hex
3	1500	223	65466 FFBA hex
4	2260	224	65466 FFBA hex
5	3400	225	65466 FFBA hex
6	5360	226	65466 FFBA hex
7	9530	227	65466 FFBA hex

Arbitration Field																								Control Field														
0	1	2	3	4	5	6	7	8	9	10	11	12	13	14	15	16	17	18	19	20	21	22	23	24	25	26	27	28	29	30	31	32	33	34	35	36	37	38
SOF	Priority 3 Bits			R1	DP	PDU Format (PF) 8 bits					SRS	IDE	PF Cont.		PDU Specific 8 bits								Source Address 8 bits								RTR	Control Field 6 bits						
X	0	1	2	0	0	0	1	2	3	4	5	X	X	6	7	0	1	2	3	4	5	6	7	0	1	2	3	4	5	6	7	X	0	1	2	3	5	6
	1	0	0		0		1	1	1	1	1			1	1	1	0	1	1	1	0	0	1	1	1	0	1	1	1	0	0							
	7				255 (FF hex)						185 (B9 hex)								219 (DB hex)																			
65467 + Address Offset																								219 Mandatory														

	bit7	bit6	bit5	bit4	bit3	bit2	bit1	bit0
Data Field	X Angle							
	X Angle							LSB
	LSB		X NEG flag		X POS flag		MSB	
	Y Angle							
	Y Angle							LSB
	Z POS flag		MSB		Y NEG flag		Y POS flag	
	Z Angle							Z NEG flag
	1		1		1		1	
1		1		1		1		
0		0		LED Weight		Sensitivity		

64 BIT DATA FIELD BIT POSITIONS

X Angle (10 bits) 0 to 1000, 0.1 per bit
X angle POSITIVE sign flag (2 bits) 01 = Positive Angle
X angle NEGATIVE sign flag (2 bits) 01 = Negative Angle
Y Angle (10 bits) 0 to 1000, 0.1 per bit
Y angle POSITIVE sign flag (2 bits) 01 = Positive Angle
Y angle NEGATIVE sign flag (2 bits) 01 = Negative Angle
Z Angle (10 bits) 0 to 1000, 0.1 per bit
Z angle POSITIVE sign flag (2 bits) 01 = Positive Angle
Z angle NEGATIVE sign flag (2 bits) 01 = Negative Angle

SENSITIVITY Setting (3 bits) Field contains the value of the current setting. 0 = most sensitive, 7 = most sluggish (default 4)
LED WEIGHT Setting (3 bits) Field contains the value of the setting. Degrees per LED Indicator, 1 to 7 (default 1)

Byte 0								Byte 1								Byte 2								Byte 3							
0	1	2	3	4	5	6	7	8	9	10	11	12	13	14	15	16	17	18	19	20	21	22	23	24	25	26	27	28	29	30	31
X Angle bit0 LSB	X Angle bit1	X Angle bit2	X Angle bit3	X Angle bit4	X Angle bit5	X Angle bit6	X Angle bit7	X Angle bit8	X Angle bit9 MSB	X Positive Flag LSB	X Positive Flag MSB	X Negative Flag LSB	X Negative Flag MSB	Y Angle bit0 LSB	Y Angle bit1	Y Angle bit2	Y Angle bit3	Y Angle bit4	Y Angle bit5	Y Angle bit6	Y Angle bit7	Y Angle bit8	Y Angle bit9 MSB	Y Positive Flag LSB	Y Positive Flag MSB	Y Negative Flag LSB	Y Negative Flag MSB	Z Angle bit0 LSB	Z Angle bit1	Z Angle bit2	Z Angle bit3

Byte 4								Byte 5								Byte 6								Byte 7							
32	33	34	35	36	37	38	39	40	41	42	43	44	45	46	47	48	49	50	51	52	53	54	55	56	57	58	59	60	61	62	63
Z Angle bit4	Z Angle bit5	Z Angle bit6	Z Angle bit7	Z Angle bit8	Z Angle bit9	Z Positive Flag LSB	Z Positive Flag MSB	Z Negative Flag LSB	Z Negative Flag MSB	UNUSED	UNUSED	UNUSED	UNUSED	UNUSED	UNUSED	UNUSED	UNUSED	UNUSED	UNUSED	UNUSED	UNUSED	UNUSED	UNUSED	Sensitivity bit0 LSB	Sensitivity bit1	Sensitivity bit2 MSB	LED Weight bit0 LSB	LED Weight bit1	LED Weight bit2 MSB	UNUSED	UNUSED