

HP58SE DIMENSIONS & GENERAL PIN OUTS

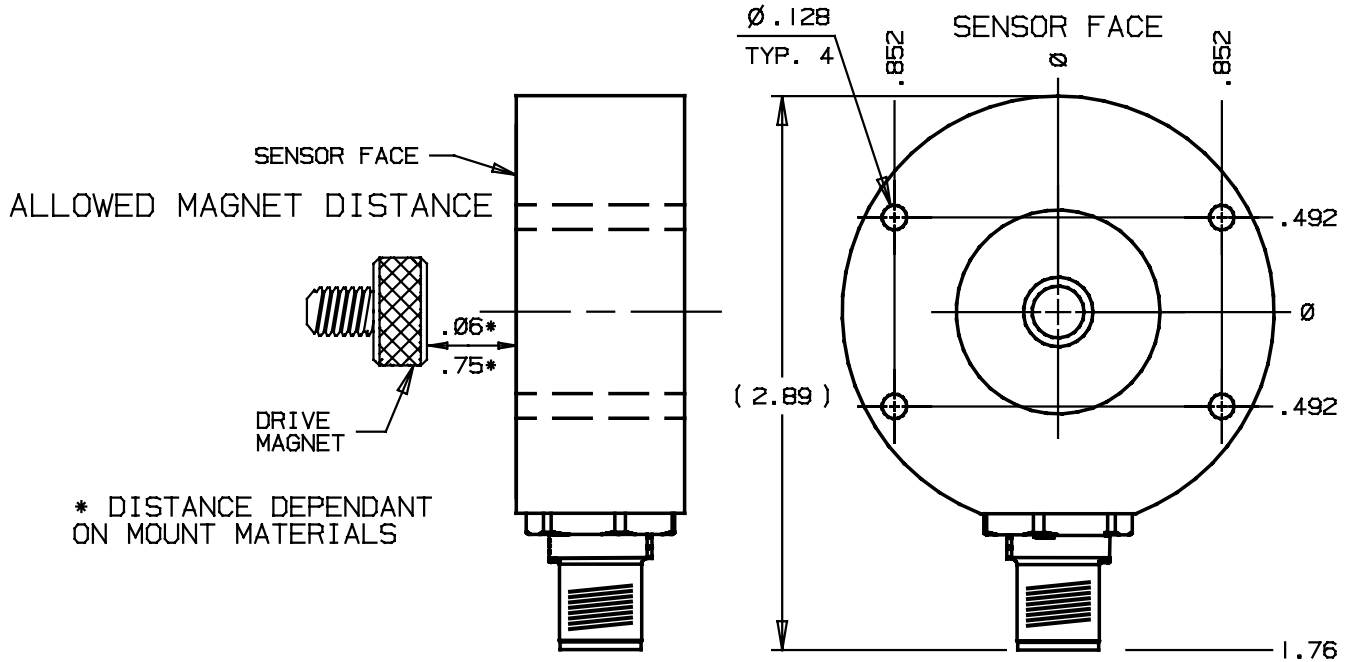

MAGNET NOTE:
STANDARD MAGNET INCLUDED AS ACCESSORY WITH PURCHASE OF NON-CONTACT SENSOR

STANDARD MAGNET
MAG-H-RING-ASSM.
1/4-20 X .47

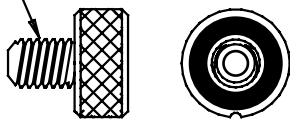

HOUSING/INSTALL NOTES:
MAGNET MOUNT MATERIALS MUST HAVE Ø1.0 [25.4] HOLE CENTERED ON SENSOR CENTERLINE

NON-MAGNETIC MOUNT MATERIAL, MAY BE SOLID
MOUNT WITH 316 STAINLESS STEEL 4-40 SCREWS

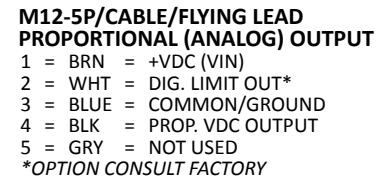
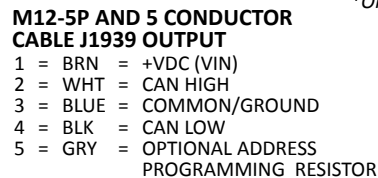
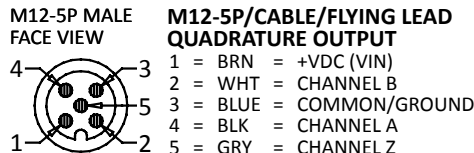
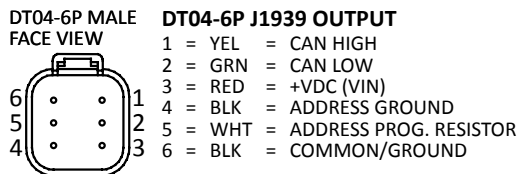
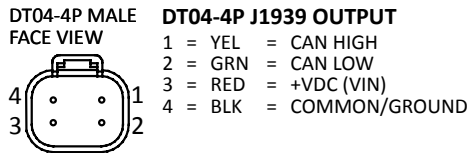
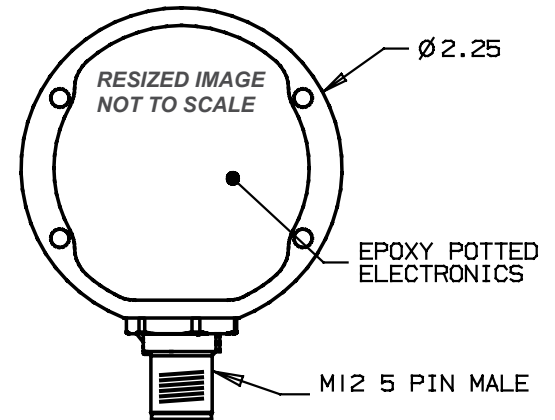

Dimensions informative only
For most recent dimensions please consult factory

